

# Proportional Relief Valves

RV1 Series

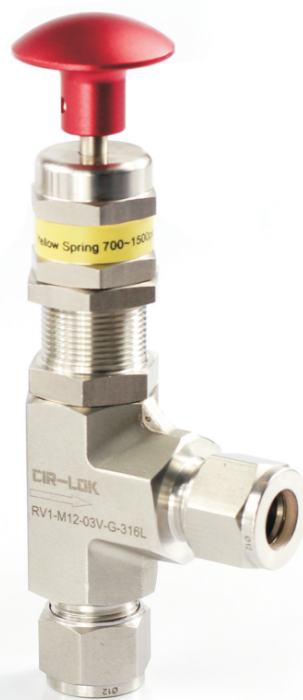

- ❖ Set pressure from 50 to 6000 psig (3.4 to 413 bar)
- ❖ Liquid or gas service
- ❖ Spring adjusts to provide desired set pressure
- ❖ Variety of end connections
- ❖ Variety of body and seal materials

## Features

- ❖ Liquid or gas service
- ❖ Set pressure from 50 to 6000 psig (3.4 to 413 bar)
- ❖ Maximum outlet pressure up to 1500 psig (103 bar)
- ❖ Spring adjusts to provide desired set pressure
- ❖ The effect of system back pressure is minimized by the design of these valves.
- ❖ 7 color-coded springs available for a wide range of set pressure

## Seal Materials

Seal Material	Temperature Range °F (°C)
Fluorocarbon FKM	25 to 250 (-4 to 121)
Buna N	0 to 250 (-17 to 121)
Neoprene	-10 to 300 (-23 to 148)
Ethylene Propylene	30 to 250 (-1 to 121)

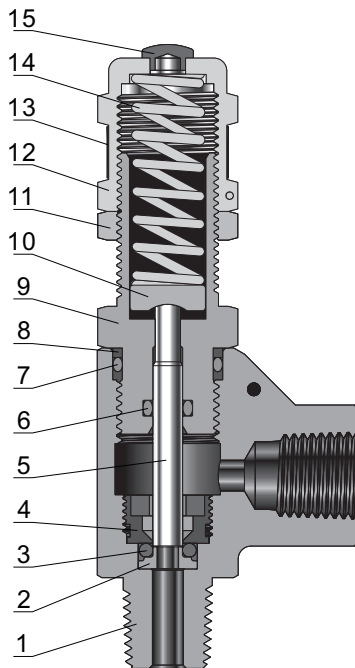

## Standard Materials of Construction

Component	Material Grade/ASTM Specification	
1	Body	316 S.S./A182
2	Insert	316 S.S./A479
3	O-ring	Fluorocarbon FKM
4	Seat retainer	316 S.S./A479
5	Stem	316 S.S./A479
6	O-ring	Fluorocarbon FKM
7	O-ring	Fluorocarbon FKM
8	Back Up Ring	PTFE
9	Bonnet	316 S.S./A479
10	Spring support	316 S.S./A276
11	Lock nut	316 S.S./A276
12	Cap	316 S.S./A479
13	Label	Polyester
14	Spring	S17700 S.S./AMS 5678
15	Plug	316 S.S./A276

## Flow Data at 70°F (20°C)

- Set Pressure 5500 psig (378 bar)
- Set Pressure 2000 psig (137 bar)
- Set Pressure 4500 psig (301 bar)
- Set Pressure 1000 psig (68.9 bar)
- Set Pressure 3500 psig (241 bar)
- Set Pressure 550 psig (37.8 bar)
- Set Pressure 2600 psig (179 bar)
- Set Pressure 350 psig (24.1 bar)
- Set Pressure 200 psig (13.7 bar)

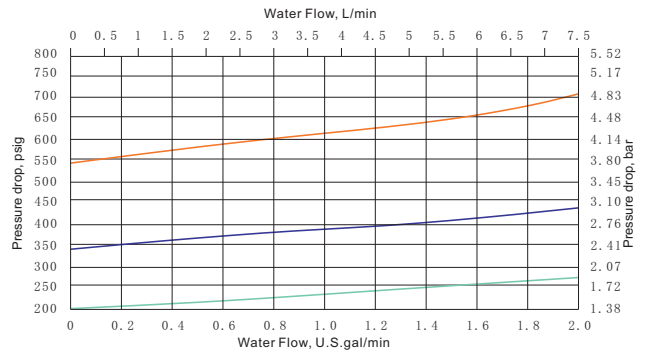
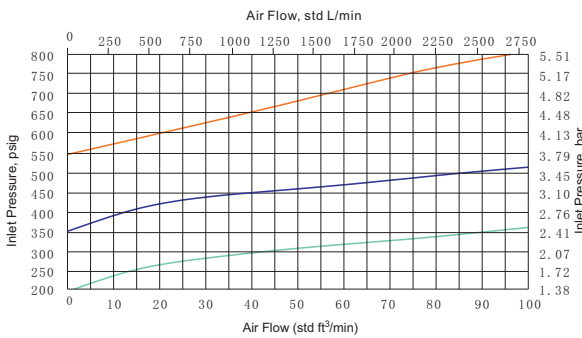
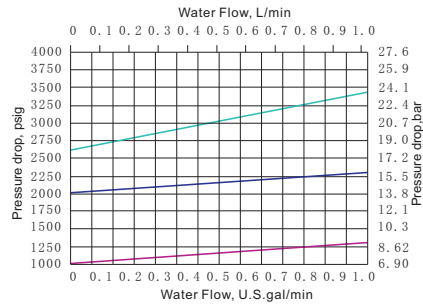
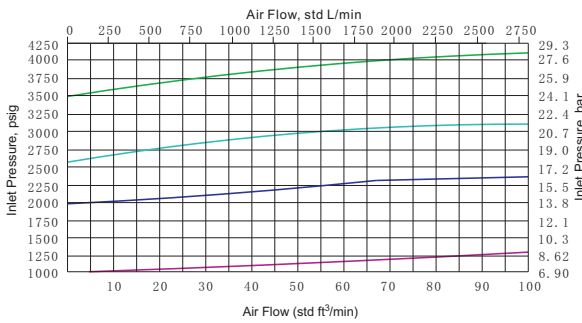
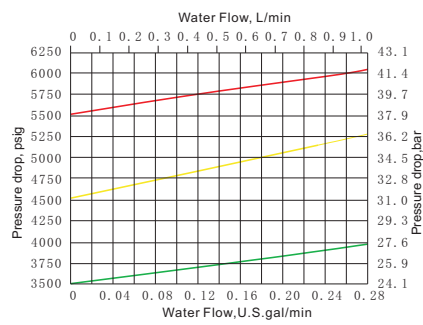
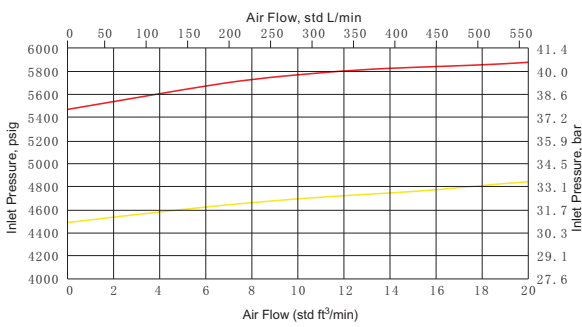

## Dimensions

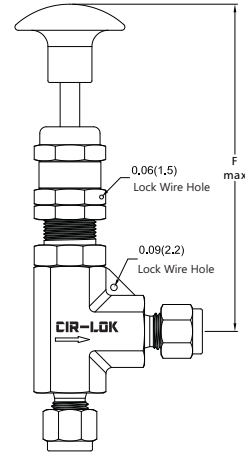
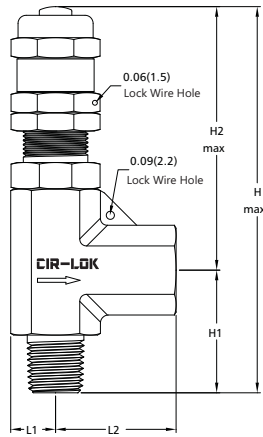

Basic Ordering Number	Connection Type and Size	Orifice in. (mm)	Dimension, in.(mm)					
			L1	L2	H1	H2max	Hmax	Fmax
RV1-F4-03-	1/4" CIR-LOK	0.14 (3.6)	0.43 (10.9)	1.60 (40.6)	1.44 (36.6)	2.70 (68.6)	4.14 (105.2)	4.09 (104)
RV1-F6-03-	3/8" CIR-LOK		0.50 (12.7)	1.72 (43.7)	1.72 (43.7)	4.09 (103.9)	5.81 (147.6)	5.37 (136)
RV1-F8-03-	1/2" CIR-LOK		0.43 (10.9)	1.60 (40.6)	1.44 (36.6)	2.70 (68.6)	4.14 (105.2)	4.09 (104)
RV1-M6-03-	6 mm CIR-LOK		0.50 (12.7)	1.83 (46.5)	1.83 (46.5)	4.09 (103.9)	5.92 (150.4)	5.37 (136)
RV1-M8-03-	8 mm CIR-LOK		0.43 (10.9)	1.38 (34.9)	1.38 (34.9)	2.70 (68.6)	4.08 (103.5)	4.09 (104)
RV1-M12-03-	12 mm CIR-LOK		0.50 (12.7)	1.43 (36.3)	1.43 (36.3)	4.09 (103.9)	5.52 (140.2)	5.37 (136)
RV1-FNPT4-03-	1/4 Female NPT		0.43 (10.9)	1.17 (29.7)	1.19 (30.2)	2.70 (68.6)	3.89 (98.8)	4.09 (104)
RV1-FNPT8-03-	1/2 Female NPT		0.50 (12.7)	1.43 (36.3)	1.43 (36.3)	4.09 (103.9)	5.52 (140.2)	5.37 (136)
RV1-NPT4-03-	1/4 Male NPT		0.43 (10.9)	1.17 (29.7)	1.19 (30.2)	2.70 (68.6)	3.89 (98.8)	4.09 (104)
RV1-NPT8-03-	1/2 Male NPT		0.50 (12.7)	1.43 (36.3)	1.43 (36.3)	4.09 (103.9)	5.52 (140.2)	5.37 (136)
RV1-FBT4-03-	1/4 Female BSPT		0.43 (10.9)	1.17 (29.7)	1.19 (30.2)	2.70 (68.6)	3.89 (98.8)	4.09 (104)
RV1-FBT8-03-	1/2 Female BSPT		0.50 (12.7)	1.43 (36.3)	1.43 (36.3)	4.09 (103.9)	5.52 (140.2)	5.37 (136)

### Spring Kits

Spring Designator	Spring Color	Set Pressure Rang psig (bar)
G	Green	50 to 300 (3.4 to 20.7)
O	Orange	300 to 700 (20.7 to 48.3)
Y	Yellow	700 to 1500 (48.3 to 103)
P	Purple	1500 to 2500 (103 to 172)
W	White	2500 to 3500 (172 to 241)
J	Blue	3500 to 4500 (241 to 310)
R	Red	4500 to 6000 (310 to 413)

### How to Order

RV1— NPT8 — FNPT8 — 03V — GM — 316

Series	Inlet Type	Inlet Size	Outlet Type	Outlet Size	Orifice	Seal Material	Spring KitColor	Manual Override Handle	Body Material
RV1	FNPT Female NPT	2 1/8 in.	Same as inlet type and inlet size		03 0.14 in. (3.6 mm)	V Fluorocarbon FKM	G Green 50~300 psig	None	316 316 S.S.
	NPT Male NPT	4 1/4 in.				B Buna N	O Orange 300~700 psig	M Manual Override Handle	316L 316L S.S.
	FBT Female BSPT	6 3/8 in. or 6mm	If outlet and inlet are the same, eliminate the outlet designator	E Ethylene propylene		Y Yellow 700~1500 psig		304 304 S.S.	
	MBT Male BSPT	8 1/2 in. or 8mm		N Neoprene		P Purple 1500~2500 psig		304L 304L S.S.	
	FMS Female ISO 261	10 10 mm		Z Kalrez		W White 2500~3500 psig			
	MS Male ISO 261	12 3/4 in. or 12mm				J Blue 3500~4500 psig			
	FBP Female BSPP					R Red 4500~6000 psig			
	MBP Male BSPP								
	F Fractional Tube Fitting								
	M Metric Tube Fitting								