

Bleed Valves and Purge Valves

BP1 and BP2 Series

Bleed Valves

- ❖ Maximum working pressure up to 10 000 psig (689 bar)
- ❖ Working temperature from -65°F to 850°F (-53°C to 454°C)
- ❖ 316 stainless steel and alloy 400 material



Purge Valves

- ❖ Maximum working pressure up to 4000 psig (276 bar)
- ❖ Working temperature from -65°F to 600°F (-53°C to 315°C)
- ❖ 316 stainless steel and Brass material



Introduction

Bleed valves can be used on instrument devices such as multi-valve manifolds or gauge valves to vent signal line pressure to atmosphere before removal of an instrument or to assist in calibration.

Features

- ❖ Maximum working pressure up to 10 000 psig (689 bar)
- ❖ Working temperature from -65°F to 850°F (-53°C to 454°C)
- ❖ Compact design for easy installation
- ❖ Back stop screw prevents accidental stem disassembly
- ❖ Vent tube directs excess liquid or gas from system lines
- ❖ 316 stainless steel and alloy-405 material
- ❖ Variety of end connections

Pressure vs. Temperature

Body Material	316 S.S.	R-405
Temperature, °F (°C)	Working Pressure, psig (bar)	
-63 (-65) to 37 (100)	10000 (689)	10000 (689)
93 (200)	9290 (640)	8800 (606)
148 (300)	8390 (578)	8240 (567)
204 (400)	7705 (530)	7960 (548)
232 (450)	7435 (512)	7940 (547)
260 (500)	7165 (493)	7920 (545)
315 (600)	6770 (466)	—
343 (650)	6660 (458)	—
371 (700)	6480 (446)	—
398 (750)	6335 (436)	—
426 (800)	6230 (429)	—
454 (850)	6085 (419)	—

Standard Materials of Construction

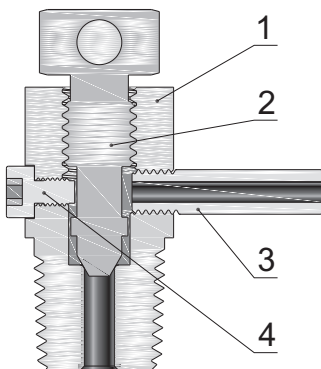

Component	Valve Body		
	Material Grade/ASTM Specification		
	316 S.S.	Alloy R-405	
1	Body	316 S.S./A479	Alloy R-405/B164
2	Stem	Chrome-plated 316 S.S./A479	Alloy R-405/B164
3	Vent tube	316 S.S./A269	Alloy R-400/B165
4	Back stop screw	316 S.S./A479	Alloy R-405/B164

Dimensions

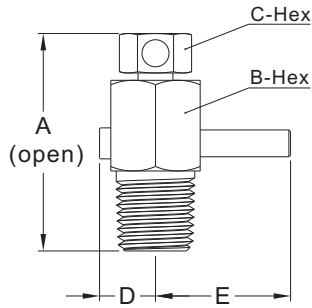

Basic Ordering Number	Inlet Type and Size	Dimension, in. (mm)				
		A (open)	B	C	D	E
BP1-NPT2	1/8 Male NPT	1.56 (39.6)	5/8 (15.9)	7/16 (11.1)	0.41 (10.4)	0.94 (23.9)
BP1-NPT4	1/4 Male NPT					
BP1-NPT6	3/8 Male NPT	1.69 (42.9)	7/8 (22.2)		0.44 (11.2)	1.03 (26.2)
BP1-NPT8	1/2 Male NPT					
BP1-MBT4	1/4 Male BSPT	1.56 (39.6)	5/8 (15.9)		0.41 (10.4)	0.94 (23.9)
BP1-MBT6	3/8 Male BSPT	1.69 (42.9)	7/8 (22.2)			
BP1-MBT8	1/2 Male BSPT				0.44 (11.2)	1.03 (23.6)
BP1-MS14	M14 x 1.5 Male ISO	1.56 (39.6)				
BP1-MS20	M20 x 1.5 Male ISO	1.69 (42.9)				

Caution

These bleed valves don't have a cap thread seal, so open the valve slowly and direct the vent hole away from the operator. These valves contain no packing, so some fluid weepage will occur when the valves are opened.

How to Order

BP1 — NPT8 — 316

Series	Inlet Type	Inlet Size	Body Material
BP1	NPT Male NPT	2 1/8 in.	316 316 S.S.
	MBT Male BSPT	4 1/4 in.	316L 316L S.S.
	MS Male ISO 261	6 3/8 in.	304 304 S.S.
	MBP Male BSPP	8 1/2 in.	304L 304L S.S.
		14 M14x1.5	A405 Alloy R-405
		20 M20x1.5	

Introduction

Purge valves are manual bleed, vent or drain valves. The cap is used to release system pressure. One-quarter turn with a wrench from finger-tight obtains leaktight closure on first makeup. Snugging with a wrench ensures closure to the rated pressure with subsequent makeups.

Features

- ❖ Maximum working pressure: 4000 psig (276 bar)
- ❖ Working temperature: -65°F to 600°F (-53°C to 315°C)
- ❖ Compact design for easy installation
- ❖ Bonnet crimped to valve body to prevent accidental disassembly
- ❖ 316 stainless steel and brass material
- ❖ Variety of end connections

Pressure vs. Temperature

Body Material	316 S.S.	Brass
Temperature, °F (°C)	Working Pressure, psig (bar)	
-53(-65) to 37 (100)	4000 (275)	3000 (206)
65 (150)	3720 (256)	2800 (192)
93 (200)	3440 (237)	2600 (179)
148 (300)	3105 (213)	2210 (152)
176 (350)	2975 (204)	1480 (101)
204 (400)	2850 (196)	740 (50.9)
232 (450)	2750 (189)	—
260 (500)	2650 (182)	—
315 (600)	2500 (172)	—

Standard Materials of Construction

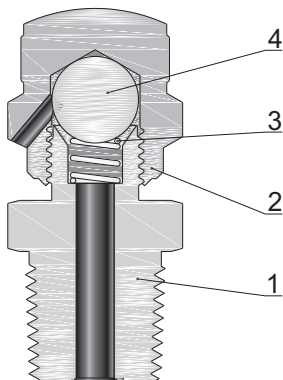

Component		Valve Body	
		Material Grade/ASTM Specification	
		316 S.S.	Brass
1	Body	316 S.S./A182 316 S.S./A479	Brass C36000/B16 Brass 377/B283
2	Cap	316 S.S./A479	Brass C36000/B16
3	Spring	303 S.S./A313	304 S.S./A313
3	Poppet (Ball)	316 S.S./A479	316 S.S./A479

Dimensions

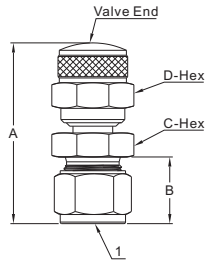

Type I

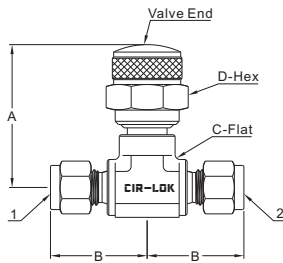

Type BT

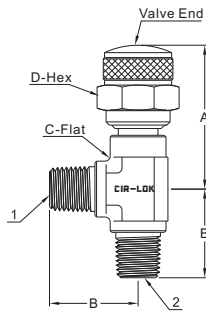

Type RT

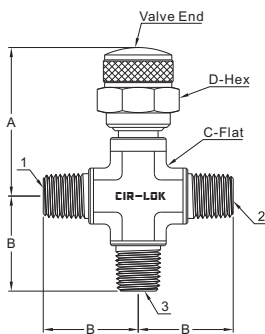

Type C

Basic Ordering Number	Connection Type and Size		Dimension, in. (mm)			
			A _{max}	B	C	D
BP2-I	-F2	1/8" CIR-LOK	1.84 (46.7)	0.59 (15.0)	5/8 (15.9)	1/2 (12.7)
	-F4	1/4" CIR-LOK	1.94 (49.3)	0.69 (17.5)	5/8 (15.9)	1/2 (12.7)
	-F6	3/8" CIR-LOK	2.03 (51.6)	0.75 (19.1)	3/4 (19.1)	5/8 (15.9)
	-F8	1/2" CIR-LOK	2.19 (55.6)	0.88 (22.4)	7/8 (22.2)	3/4 (19.1)
	-M6	6 mm CIR-LOK	1.94 (49.3)	0.69 (17.5)	5/8 (15.9)	1/2 (12.7)
	-M8	8 mm CIR-LOK	2.00 (50.8)	0.72 (18.3)	5/8 (15.9)	1/2 (12.7)
	-M10	10 mm CIR-LOK	1.05 (26.7)	0.75 (19.1)	3/4 (19.1)	5/8 (15.9)
	-M12	12 mm CIR-LOK	1.05 (26.7)	0.88 (22.4)	7/8 (22.2)	3/4 (19.1)
	-FNPT2	1/8 Female NPT	1.56 (39.6)	0.53 (13.5)	5/8 (15.9)	1/2 (12.7)
	-FNPT4	1/4 Female NPT	1.75 (44.4)	0.72 (18.3)	5/8 (15.9)	5/8 (15.9)
	-FNPT6	3/8 Female NPT	1.81 (46.0)	0.78 (19.8)	7/8 (22.2)	3/4 (19.1)
	-FNPT8	1/2 Female NPT	1.98 (50.3)	0.97 (24.6)	1 1/16 (26.9)	7/8 (22.2)
	-NPT2	1/8 Male NPT	1.62 (41.1)	0.38 (9.7)	5/8 (15.9)	1/2 (12.7)
	-NPT4	1/4 Male NPT	1.81 (46.0)	0.56 (14.2)	5/8 (15.9)	5/8 (15.9)
	-NPT6	3/8 Male NPT	1.84 (46.7)	0.56 (14.2)	3/4 (19.1)	3/4 (19.1)
	-NPT8	1/2 Male NPT	2.09 (53.1)	0.75 (19.1)	7/8 (22.2)	7/8 (22.2)
BP2-BT BP2-RT BP2-C	-F2	1/8" CIR-LOK	0.90 (22.9)	0.88 (22.4)	5/8 (15.9)	1/2 (12.7)
	-F4	1/4" FITOK	1.08 (27.3)	1.06 (26.9)	5/8 (15.9)	1/2 (12.7)
	-F6	3/8" CIR-LOK	1.22 (31.0)	1.20 (30.5)	3/4 (19.1)	5/8 (15.9)
	-F8	1/2" CIR-LOK	1.44 (36.6)	1.42 (36.1)	7/8 (22.2)	3/4 (19.1)
	-M6	6 mm CIR-LOK	1.08 (27.5)	1.06 (27.0)	5/8 (15.9)	1/2 (12.7)
	-M8	8 mm CIR-LOK	14.97 (30.4)	14.95 (29.9)	5/8 (15.9)	1/2 (12.7)
	-M10	10 mm CIR-LOK	1.34 (34.0)	1.32 (33.5)	3/4 (19.1)	5/8 (15.9)
	-M12	12 mm CIR-LOK	1.43 (36.5)	1.41 (36.0)	7/8 (22.2)	3/4 (19.1)
	-FNPT2	1/8 Female NPT	0.68 (17.3)	0.66 (16.8)	5/8 (15.9)	1/2 (12.7)
	-FNPT4	1/4 Female NPT	0.90 (22.9)	0.88 (22.4)	5/8 (15.9)	5/8 (15.9)
	-FNPT6	3/8 Female NPT	1.03 (26.2)	1.01 (25.7)	7/8 (22.2)	3/4 (19.1)
	-FNPT8	1/2 Female NPT	1.25 (31.7)	1.23 (31.2)	1 1/16 (26.9)	7/8 (22.2)
	-NPT2	1/8 Male NPT	0.78 (19.8)	0.76 (19.3)	5/8 (15.9)	1/2 (12.7)
	-NPT4	1/4 Male NPT	1.11 (28.2)	1.09 (27.7)	5/8 (15.9)	5/8 (15.9)
	-NPT6	3/8 Male NPT	1.24 (31.5)	1.22 (31.0)	3/4 (19.1)	3/4 (19.1)
	-NPT8	1/2 Male NPT	1.52 (37.8)	1.47 (37.3)	7/8 (22.2)	7/8 (22.2)

Caution:

These purge valves don't have a cap thread seal, so open the valve slowly and direct the vent hole away from the operator. These valves contain no packing, so some fluid weepage will occur when the valves are opened.

How to Order

BP2 — BT — M10 — FNPT4 — 316

Series	Type	Port 1 Type	Port 1 Size	Port 2/3 /4 Type	Port 2/3 /4 Size	Body Material
BP2	I Inline	FNPT Female NPT	2 1/8 in.	Same as port 1 type and port 1 size If port 2/3/4 and port 1 are the same, eliminate the port 2/3/4 designator		316 316 S.S.
	BT Branch Tee	NPT Male NPT	3 3 mm			316L 316L S.S.
	RT Run Tee	FBT Female BSPT	4 1/4 in.			304 304 S.S.
	C Cross	MBT Male BSPT	5 5/16 in.			304L 304L S.S.
		FMS Female ISO 261	6 3/8 in. or 6 mm			BR Brass
		MS Male ISO 261	8 1/2 in. or 8 mm			
		FBP Female BSPP	10 10 mm			
		MBP Male BSPP	12 12 mm			
		F Fractional Tube Fitting				
		M Metric Tube Fitting				